

ThermAbate®

Insulated cavity closers for closing cavities around masonry wall openings

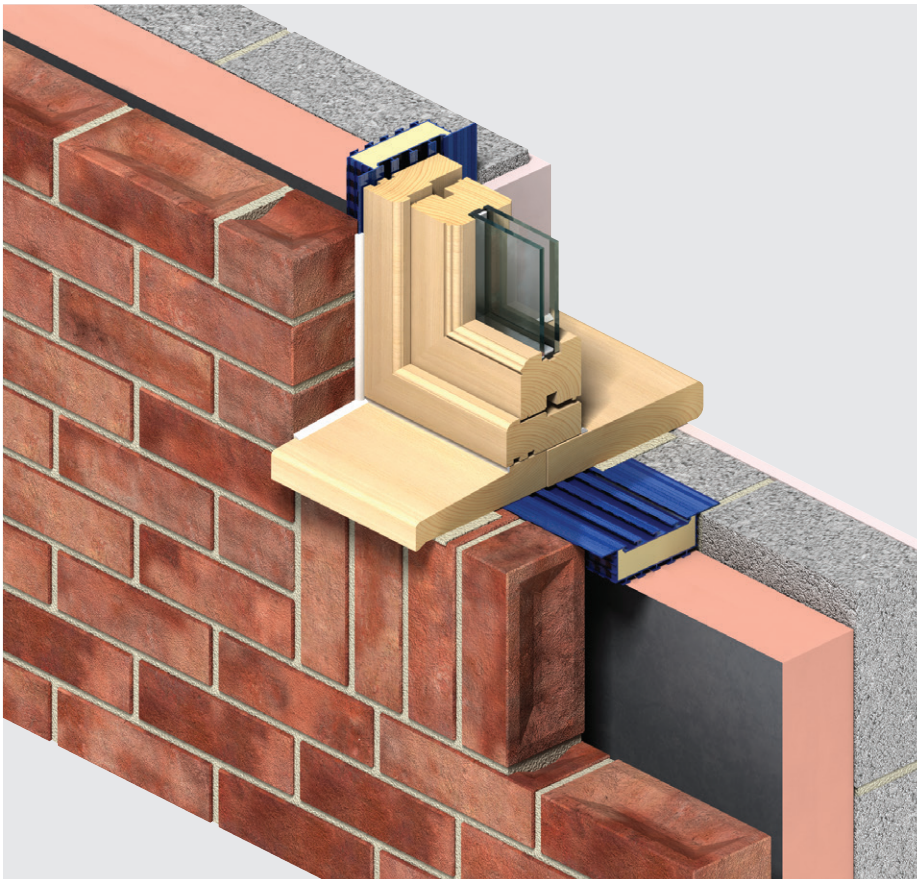

- For use in England & Wales only
- Continuous insulation - maintains a continuous insulated cavity closer around door and window openings
- Simplified construction - avoids the need for cut bricks, blocks or special reveal blocks
- Inhibited heat transfer - reduces thermal bridging, condensation risk and mould growth
- Weather resistant - forms an integral DPC
- Can be fitted with door / window frames as a combined unit
- Unaffected by air-infiltration
- Easy to handle and install

Design considerations

Introduction

Kingspan Thermabate® is a cavity closer box section comprising a uPVC extrusion with a high performance fibre-free rigid thermoset urethane core.

Kingspan Thermabate® provides a simple and effective method for closing cavities around openings in masonry cavity wall constructions in England & Wales. For other construction types and constructions in Scotland, please contact the Kingspan Insulation Technical Service Department (see rear cover for details) for further advice.

Suitable for use in both new build and refurbishment, Kingspan Thermabate® is compatible with timber, metal and composite window frames, where the frame and internal lining meet the requirements of acting as a cavity barrier. The thermally efficient insulation core inhibits heat transfer and thus reduces thermal bridging, whilst the uPVC casing provides a damp proof barrier.

There are restrictions placed upon this product which vary dependant on building type, height, construction and location. For guidance regarding the routes to compliance for meeting the fire safety requirements of the Building Regulations / Standards, refer to the relevant links to Government websites at www.kingspaninsulation.co.uk/fireregulations.

Kingspan Thermabate® is a cavity closer. Current guidance to the Building Regulations should be considered with regard to the performance requirements for, and the provision of, fire stops and cavity barriers.

The proper use of Kingspan Thermabate® can reduce the risk of condensation forming at reveals and thus unsightly mould growth, which can lead to the deterioration of plaster, paintwork and wallpaper - problems commonly associated with the use of traditional methods for the closing of cavities.

Kingspan Thermabate® sections are manufactured in profile widths ranging from 100-150 mm (Figure 1). The smaller section (100 mm) is single flanged whilst the larger sections (110, 125, 140 & 150 mm) are twin flanged - the widest of which forming the primary flange. The casing incorporates tee projections along the two widest plane lengths, which form an effective key for the direct application of plaster or screed, and fins along the two narrowest plane lengths for bedding to mortar.

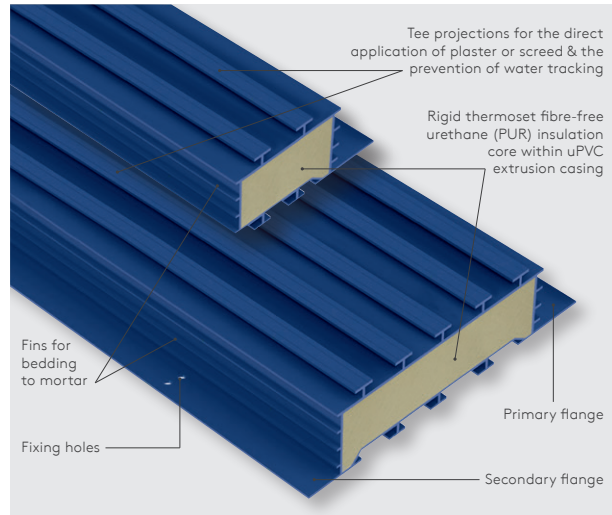

Figure 1: Kingspan Thermabate® sections

To maximise the efficiency and scope for variable design options, a complete line of accessories is also available.

This document covers the use of Kingspan Thermabate® in masonry cavity wall constructions only.

Design considerations

Typical design detail

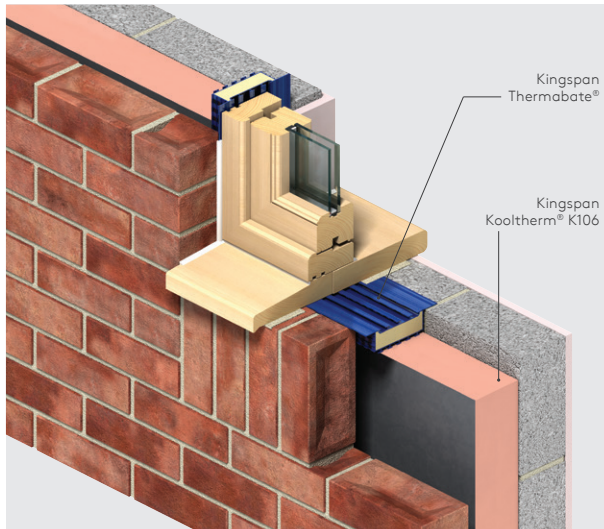

Figure 2: Kingspan Thermabate® in a masonry cavity wall construction with Kingspan Kooltherm® K106 Cavity Board

Specification clause

Kingspan Thermabate® should be described in specifications as:

The insulated cavity closer shall be Kingspan Thermabate® ___* mm comprising a one piece, rigid, box section, uPVC extrusion, with mortar fins, tee keys for direct plaster / screed application, projecting fixing flange/s, and fibre-free rigid thermoset urethane insulation core. The product shall be manufactured under a management system certified to ISO 9001: 2015, ISO 14001: 2015, ISO 45001: 2018, ISO 50001: 2018, and ISO 37301:2021 and shall be installed in accordance with the instructions issued by Kingspan Insulation Limited.

* Insert width of section.

Product classifications

Uniclass UK

Pr_35_90_50_64 Plastics cavity closers

CAWS

F30 18 (Minor Works)

F30 180 (Standard and Intermediate)

Details also available at source.thenbs.com

Linear thermal bridging

Basic principles

Linear thermal bridging describes the heat loss / gain that occurs at junctions between elements e.g. where an external wall meets the ground floor, or at junctions around openings in the building fabric where the thermal insulation layer is discontinuous e.g. sills, jambs and lintels around the windows in a masonry cavity wall construction.

Interruptions within the insulation layer by materials with poorer insulating properties can result in a thermal bridge, which in turn can lead to problems of condensation and mould growth especially if there is a drop in surface temperature.

The heat flow at these junctions and opening locations, over and above that through the adjoining plane elements, is the linear thermal transmittance of the thermal bridge: measured in W/mK; referred to as a 'psi-value'; and expressed as a ' ψ -value'.

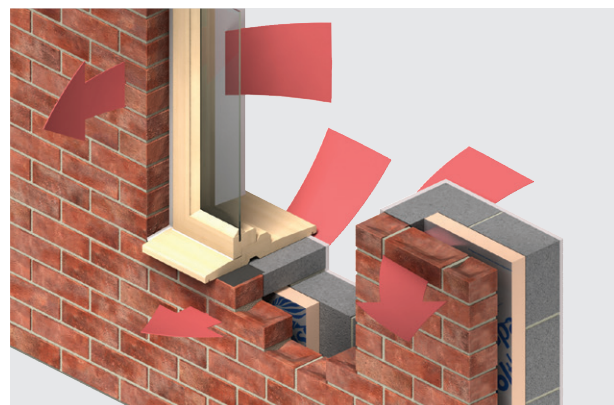

Figure 3: Heat loss paths around a typical window opening in a masonry cavity wall construction

The lower the ψ -value, the better the performance. ψ -values are taken into account in the calculation methodologies e.g. the Standard Assessment Procedure (SAP), that are used to assess the operational CO₂ emissions and, where applicable, the fabric energy efficiency of buildings, primary energy or delivered energy rates.

ψ -values can comprise either, or a combination of, calculated and assumed values.

Reducing linear thermal bridging

Detailing at junctions to minimise the effects of thermal bridging and the associated risk of condensation or mould growth is important and there are some simple design considerations that can be adopted to help mitigate the risks and to reduce heat losses.

At a window or door opening, the primary linear thermal bridge is the reveal. This can be reduced by insulating the reveal. The key factor is the thermal resistance (R-value) of the insulation layer. Reveals should be designed to accommodate a minimal thickness of Kingspan Kooltherm® K118 Insulated Plasterboard.

Design considerations

Improved thermal performance can also be achieved by reducing the overlap between the external brickwork and the opening frame. Increasing the overlap between the frame and Kingspan Thermabate® maximises the benefits of using an insulated cavity closer by reducing the heat lost through the junction.

Typical details

A variety of constructions can be formed with the use of Kingspan Thermabate® to suit differing scenarios. The details shown in Figures 4-13 illustrate the design flexibility of Kingspan Thermabate®.

NB Whilst any detail can be used in England and Wales exposure zones 1 and 2, only a check reveal or a detail using either a Standard Flange Clip or a Reveal Clip can be used in exposure zones 3 and 4 (Figures 9, 10 & 13).

Jamb details

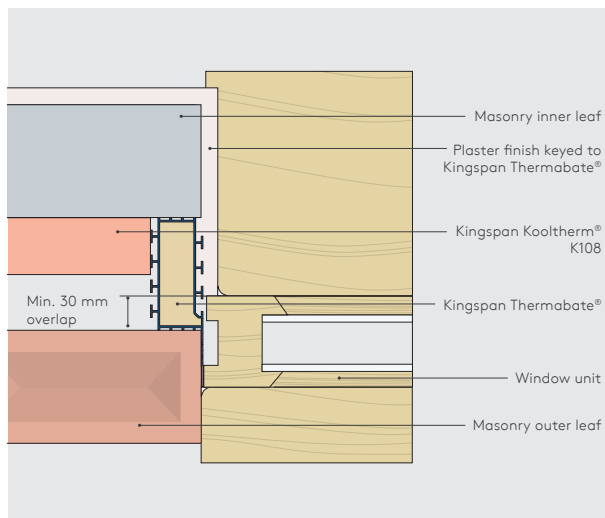

Figure 4: Flush reveal

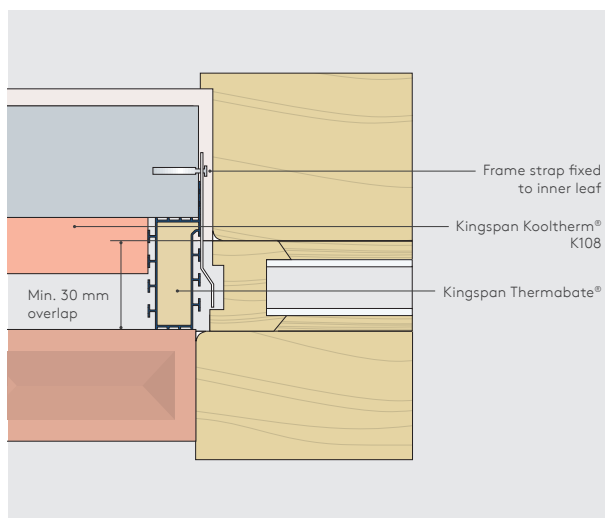

Figure 5: Window frame fitted in a separate fix to Kingspan Thermabate®

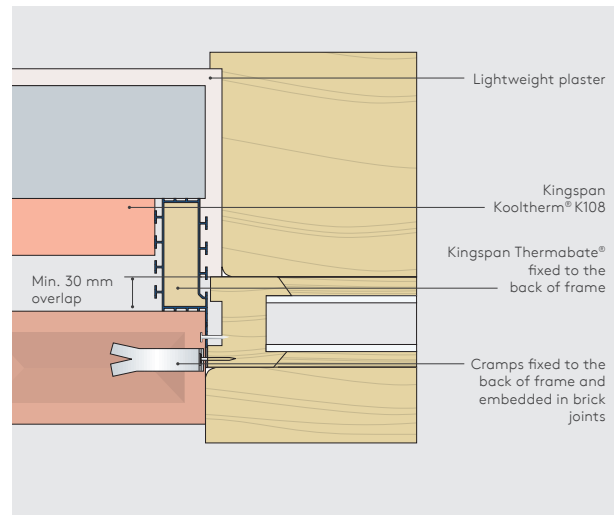

Figure 6: Window frame & Kingspan Thermabate® fitted as a combined unit

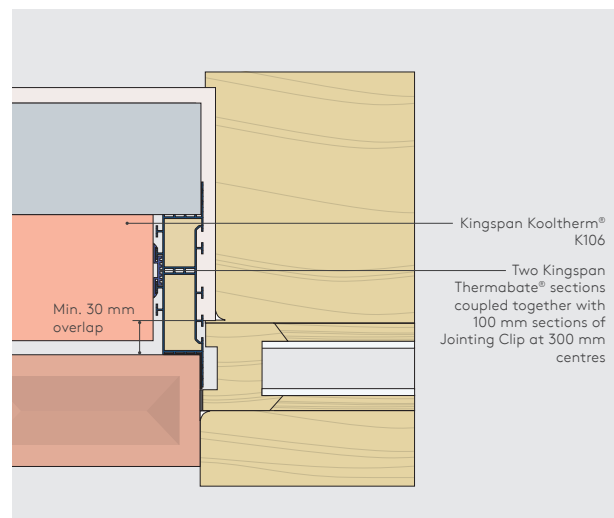

Figure 7: Two Kingspan Thermabate® sections coupled 'back-to-back' with a jointing clip

Design considerations

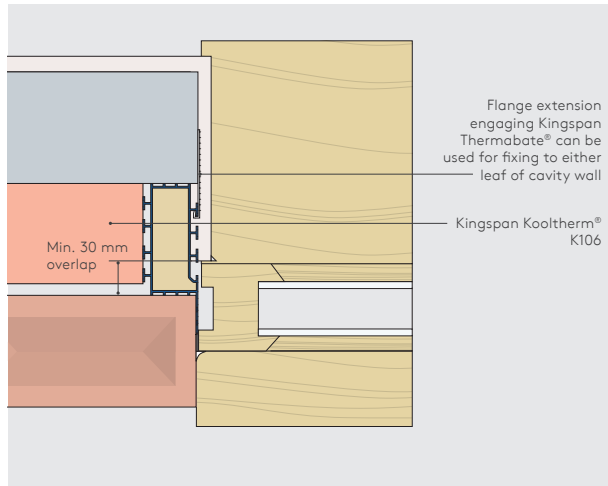

Figure 8: Use of a flange extension clip

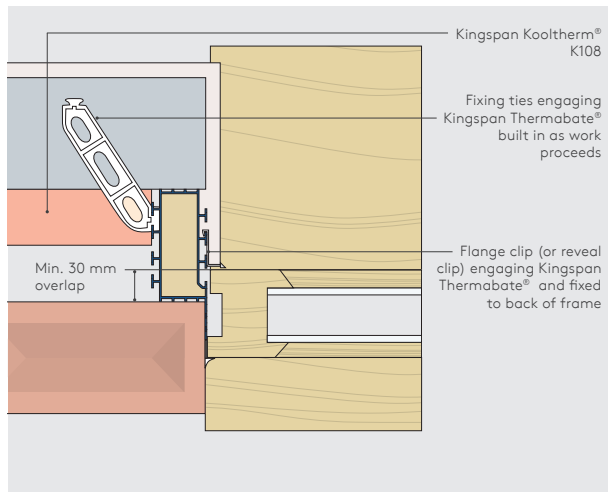

Figure 9: Use of an optional fixing tie & either a standard flange clip or reveal clip

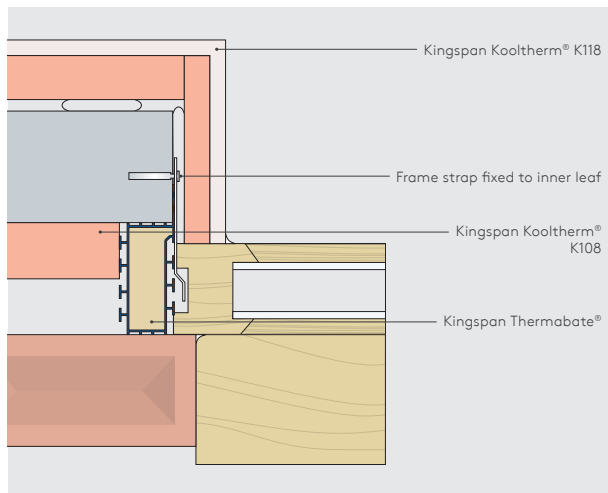

Figure 10: Check reveal

Lintel detail

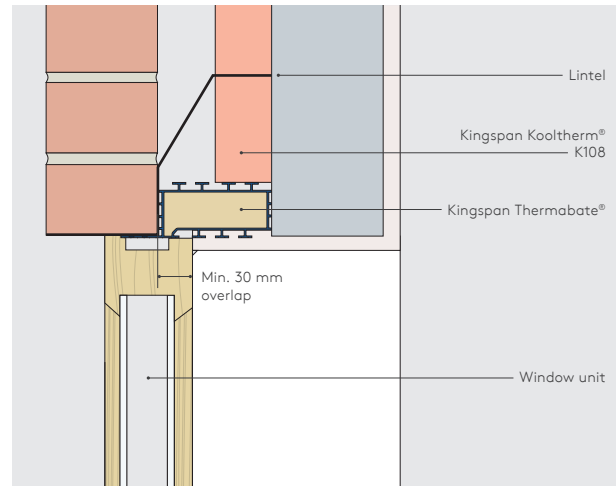

Figure 11: Kingspan Thermabate® at lintel

Sill details

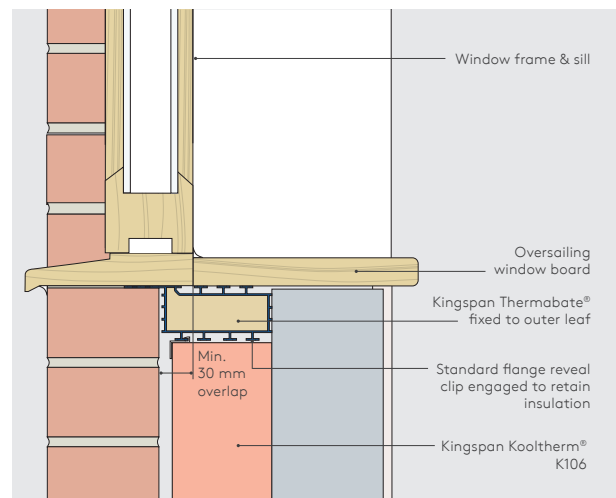

Figure 12: Flush reveal & minimum 30 mm overlap

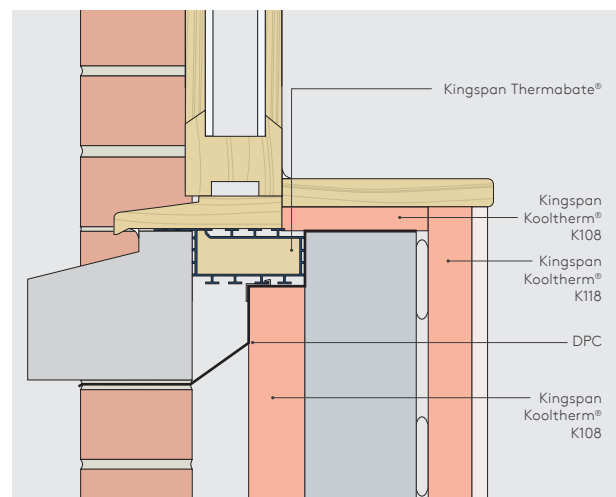

Figure 13: Check reveal

Sitework

Selecting a section

- The profile width of the section, frame, or, if necessary, combination of sections to be used will be determined by the width of the cavity to be closed.
- Where a check reveal is required, or where a door or window frame is required to be set further back into the reveal (Figure 15), the secondary, i.e. the narrow flange on larger sections, should be removed.
- Two sections can be coupled back-to-back along their length by joining one finned plane from each section together with a Jointing Clip (Figure 34). To facilitate coupling on larger sections, the removal of one of the flanges is necessary.
- Although two sections can be coupled back-to-back, in order to suit cavity widths of up to 300 mm, Kingspan Insulation recommends the use of Kingspan Kooltherm® Cavity Closer for cavity widths greater than 150 mm. For further information, go to:
www.kingspaninsulation.co.uk/kkcc.

Installation for masonry cavity walls

Basic principles

- Kingspan Thermabate® should be built-in as the wall is being constructed (Figure 15), keying mortar from bed joints to the fins on the casing (Figure 19 A & B).



Figure 14: Kingspan Thermabate® built-in as the wall is being constructed

- The flange (in the case of larger sections, the primary flange) can be fixed to either the inner or outer leaf of the masonry.
- To enable the window frame to be set further back into reveals, particularly if a check reveal is required, fix the flange to the inner leaf (Figure 19).

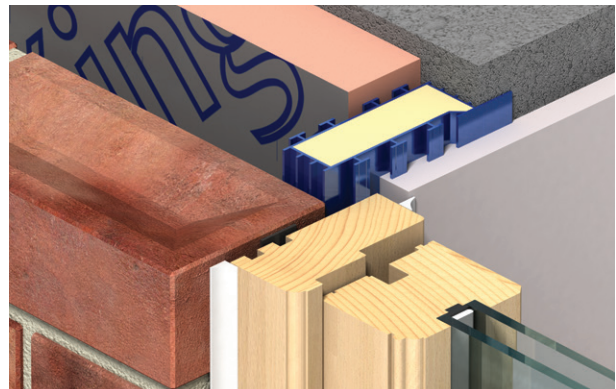

Figure 15: Flange fixed to the inner leaf

- Flange/s should always be positioned tight against the masonry and securely fixed to the masonry with a suitable fixing through the holes in the flange/s (Figure 16 C).
- Sections and frames should be fitted tight within the cavity and, ideally, no gaps should be left between them and either wall leaf.
- In the circumstance where the section or frame, exclusive of the flange/s, does not fully fill the cavity, the appropriately sized section or frame should span the cavity such that the residual gap, which should be no greater than 10 mm, is situated behind the flange (Figure 16 D).
- Incorporate an appropriate lintel and damp proof course at the head of the opening.
- Where an insulated lintel is used, a head section or head side of the frame is not required. Jamb sections or jamb sides of the frame are butted up against the lintel. If required, a section can be used at the head where a separate lintel is used for each leaf.
- For refurbishment works, refer to 'Replacement windows / doors' in the 'Window frames' section of this document.

Sitework

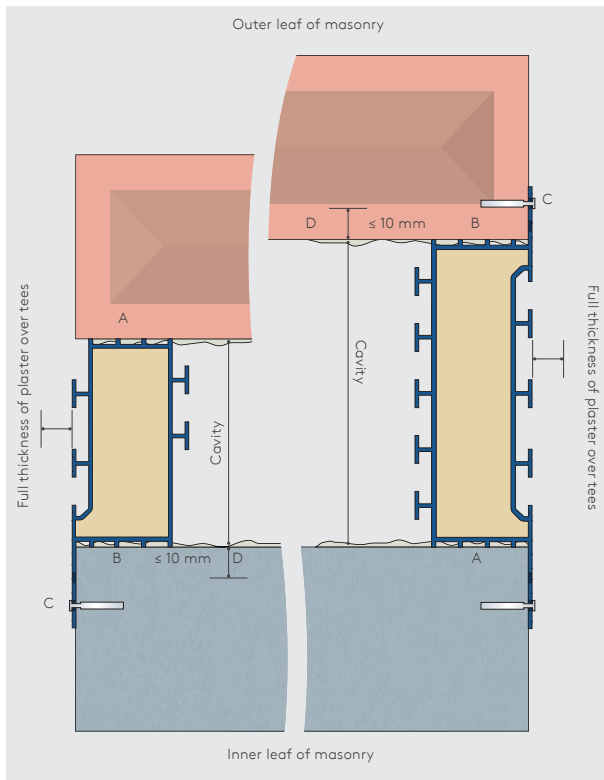

Figure 16: Basic installation principles

Installing individual sections

- Install Kingspan Thermabate® sill, jamb and head sections individually as the wall is being constructed.
- For sills, cut sections precisely to match the width of the opening.
- For jambs, cut sections such that they overhang the bottom of the sill by 50 mm, removing the flange/s as necessary in order to enable the sections to fit into the cavity under the sill edge of the opening.
- If used at the head, cut sections to extend 50 mm beyond each jamb section, again removing the flange/s as necessary.

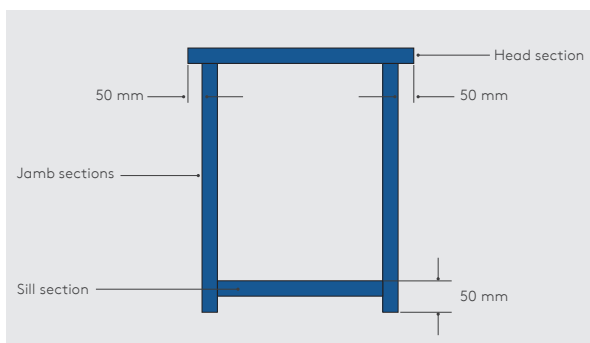

Figure 17: Kingspan Thermabate® sill, jamb & head sections

Fabricating frames on site

- Fabricate a frame on site using Kingspan Thermabate®, install as a unit and then construct the wall around it.
- Cut sections as per the guidance given in 'Installing Individual Sections'.
- On a level surface, assemble the cut sections to form the frame, securely fixing a Profile Bracket (Figure 36) in each 90° corner.
- For extra rigidity, fit timber cross bracings to the Profile Brackets as necessary, checking the diagonal dimensions to ensure that the frame is square and that its shape is maintained.

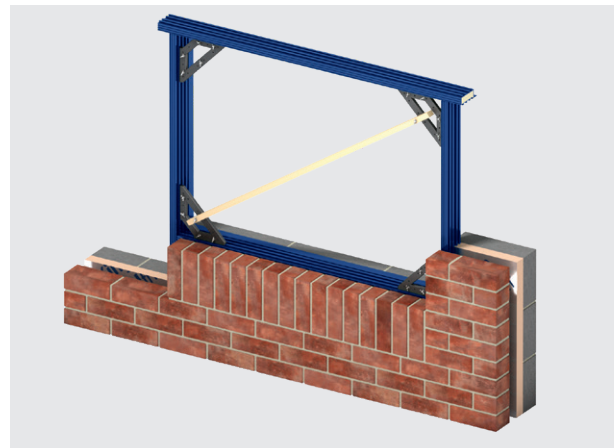

Figure 18: Frame fabricated on site using Kingspan Thermabate®

Installing frames

- When the wall reaches sill level, place the Kingspan Thermabate® into the cavity, ensuring that it is adequately supported until the wall is sufficiently constructed.
- Build the wall around the jamb sides of the frame, attaching fixing ties (Figure 37) to the tees at the back of the Kingspan Thermabate® casing and bedding them fully into the mortar joints.
- Once construction of the wall is complete and the mortar is set, remove any timber bracing, unscrew any Profile Brackets, which can be re-used, and then fix the frame to the masonry with a suitable fixing through the holes in the flange.

Sitework

Window frames & boards

Fitting in a separate fix to Kingspan Thermabate®.

- Offer up the window frame, wedge into position and then secure to the masonry.
- If required, use Standard Flange Clips to fix the window frame to the Kingspan Thermabate® (Figure 19).



Figure 19: Kingspan Thermabate® in position with reveal clip engaged behind window frame

Fitting as a combined unit

- Fix Kingspan Thermabate® to the window frame with appropriate fixings using the pre-drilled holes in the flange where applicable (Figure 20).
- Install as per the guidance given for 'Installing frames', but instead of attaching Fixing Ties and bedding them into the mortar joints; and also fixing Kingspan Thermabate® to the masonry through the holes in the flange, fix cramps to the back of the window frame and embed in brick joints.

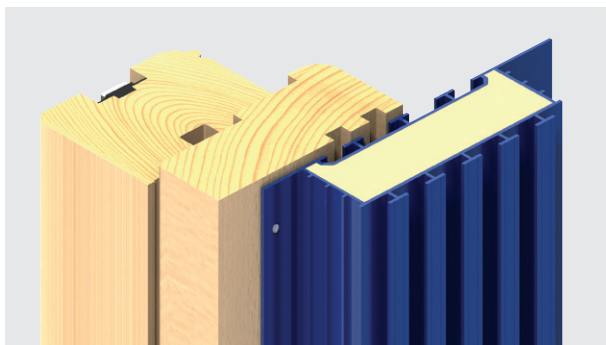

Figure 20: Kingspan Thermabate® pre-fixed to back of window frame

Replacement windows / doors

- Cut out and clear away any debris within the cavity.
- Secure the Kingspan Thermabate® into position with wedges and fixings through the holes in the flange to ensure that the insulation is tightly fixed within the cavity and that no movement can occur.
- Offer up the window / door frame, secure to the masonry and use Standard Flange Clips to fix the frame to the Kingspan Thermabate® sections.

Oversailing window boards

- Window boards should be fitted conventionally.
- Direct fixing of window boards to Kingspan Thermabate® alone will not suffice (Figure 21). Where an embedded tiled inner sill or threshold is required, the tees on the Kingspan Thermabate® casing form a key for cement bedding.

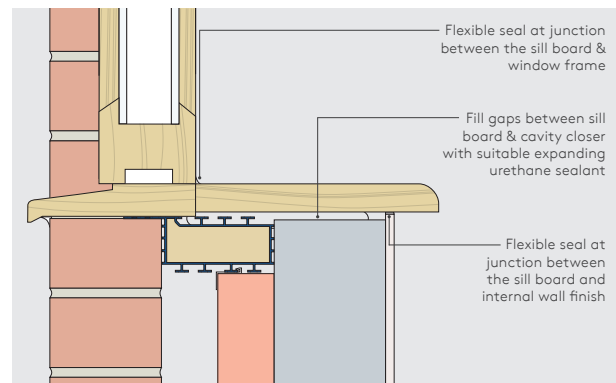

Figure 21: Oversailing window board

Sitework

General

Cutting

- Kingspan Thermabate® should be cut using a fine toothed saw in such a manner that cross-sectional cuts are square.
- The removal of flanges from larger sections, when necessary, should be carried out by scoring along the length of the join with a utility knife and then snapping the flange off.

Butt jointing

- Ideally, there should be no more than one joint per side of the frame.
- To facilitate good square alignment, factory-cut ends should be butted in preference to those cut on site.
- A jointing strip (Figure 35) should be used to align and connect the two abutting sections as sections are being built-in.
- A high strength self-adhesive aluminium foil tape, no less than 100 mm wide, should be applied around the joint to prevent water tracking.

Finishing

- Plaster, screed and dabs for dry-lining should be applied directly to the tees on the Kingspan Thermabate® casing, as the tees form the key. The tops of tees should be flush with the masonry reveal (Figure 22).
- Note that the first coat of plaster should be pricked up into the tees and then scored as a key for the next coat of plaster.
- Where Kingspan Thermabate® is used in conjunction with a floor screed at a door threshold, in order to prevent cracking, the screed should either be of a sufficient thickness i.e. no less than 65 mm, or reinforced.

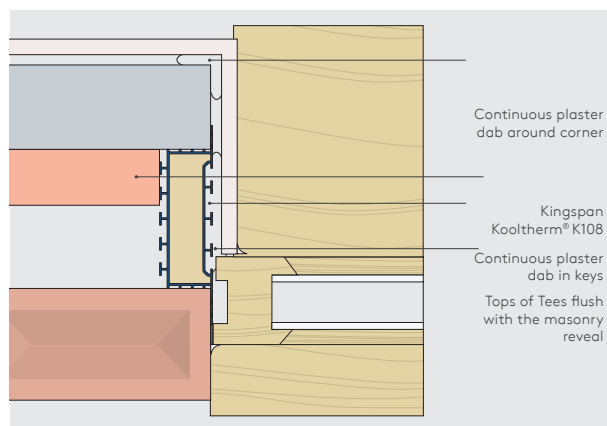

Figure 22: Plaster dabs at jamb detail

Limitations

- Kingspan Thermabate® is not loadbearing and therefore must not be used to support door or window frames, or used in place of normal cavity wall ties.

Packaging & storage

- Kingspan Thermabate® is supplied in recyclable polyethylene packs. Polyethylene packaging should not be considered adequate for outdoor protection.
- Care should be taken when handling, transporting and storing sections and frames to prevent physical damage. To prevent distortion, they should be stored such that they are propped vertically and should not be exposed to excessive heat.
- Sections and frames should be maintained in good condition throughout the duration of the works and should not be unpacked on site until required for immediate use. They should be returned to storage at the end of each workday.
- Ideally, sections and frames should be stored inside a building. If, however, storage outside cannot be avoided, they should be stored in a dry atmosphere, clear of the ground, out of direct sunlight and covered with an opaque and weatherproof material. Sections and frames should not be used where the insulation core has been allowed to get wet.

Health & safety

- Care should be taken when handling the cut ends of sections.
- Kingspan Insulation products are chemically inert and safe to use.
- A Safety Information Data Sheet for this product is available from the Kingspan Insulation website www.kingspaninsulation.co.uk/safety.

Product details

Product description

Kingspan Thermabate® is a cavity closer box section comprising a uPVC extrusion with a high performance fibre-free rigid thermoset urethane insulation core.



Kingspan Thermabate® sections are manufactured in profile widths ranging from 100-150 mm (Figures 23-27) and are available as standard in 3 metre lengths.

Kingspan Thermabate® is available from specialist insulation distributors and selected builders' merchants.

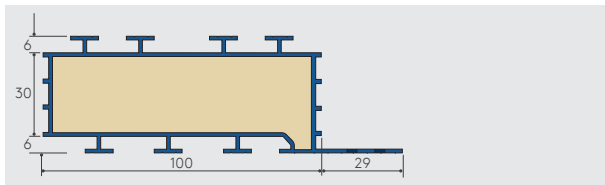

Figure 23: Kingspan Thermabate® 100

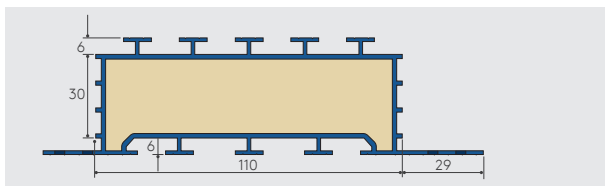

Figure 24: Kingspan Thermabate® 110

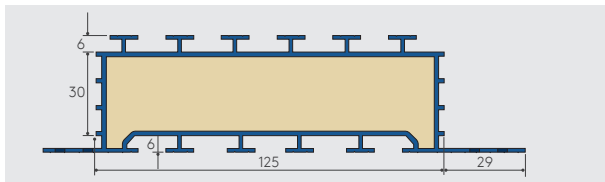

Figure 25: Kingspan Thermabate® 125

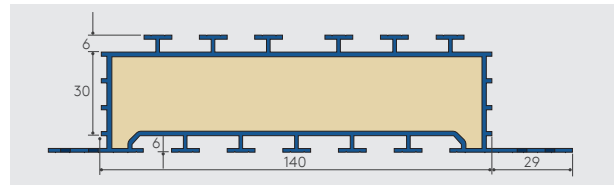

Figure 26: Kingspan Thermabate® 140

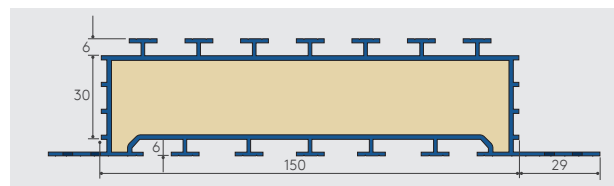

Figure 27: Kingspan Thermabate® 150

Product details

Accessories

Kingspan Thermabate® is complemented by a full range of accessories to maximise the efficiency and scope for variable design options. Clips and strips are supplied in one metre lengths and are colour coded.

Standard Flange Clip

For use as a weather check, for fixing closer sections to window frames, and for retaining partial fill insulation batts in the cavity.

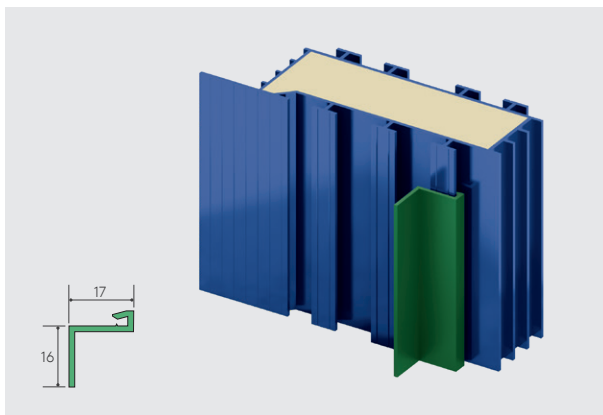

Figure 28: Standard Flange Clip – Green

Reveal Clip

Aids construction of check reveals and gives additional protection to the frame assembly. It is available in a depth of 26 mm.

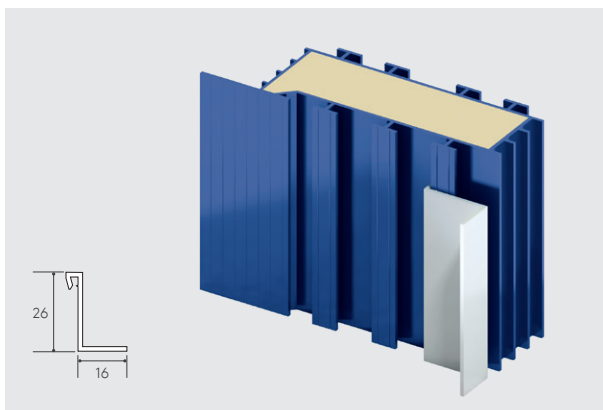

Figure 29: Reveal Clip - White

Flange Extension Clip

Clips over Kingspan Thermabate® to extend the width of the fixing flange. It enables positive fixing of frame over suspect masonry.

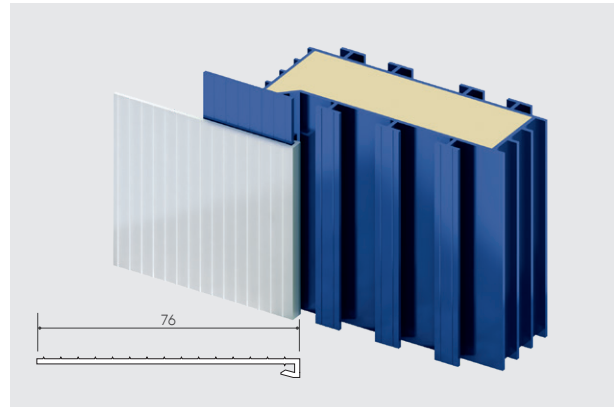

Figure 30: Flange Extension Clip - White

Jointing Clip

Connects two sections back-to-back along their length to suit cavity widths of up to 300 mm in circumstances where a single section, Kingspan Kooltherm® Cavity Closer will not suffice. It should be installed in 100 mm lengths at 300 mm centres.

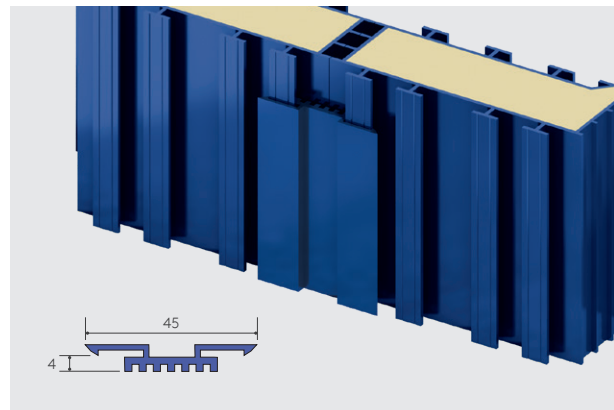

Figure 31: Jointing Clip - Blue

Product details

Jointing Strip

Aligns and connects two abutting sections along their cross-sectional plane. It allows for opening sizes greater than 2.4 metres, and for the reduction of wastage through the use of off-cuts. Limited to one butt joint per side of the opening.

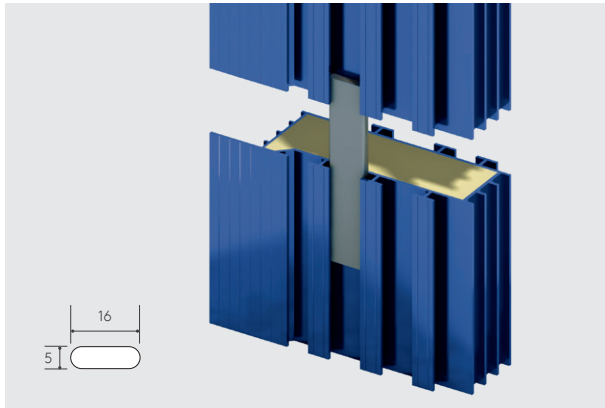

Figure 32: Jointing Strip - Grey

Profile Bracket

Designed for use when frames are fabricated on site. Made from strong polypropylene, it is reusable and is supplied as a set in packs of four.

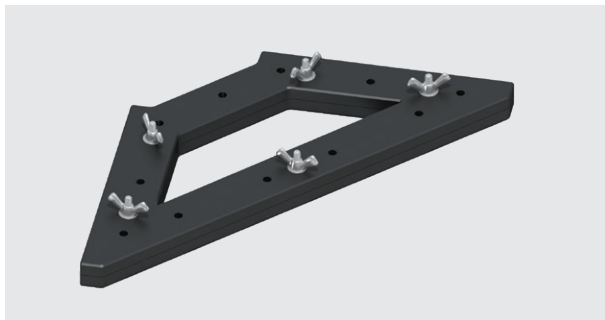

Figure 33: Profile Bracket - Black

Optional Fixing Tie

Particularly useful for wider cavities and / or in using Kingspan Thermabate® to form openings. It is designed with different angled ends which slot securely between the tees at the 'back' of the section or frame and keys fully into the mortar bed joint of either masonry leaf. It is moulded uPVC and is supplied in packs of 150.



Figure 34: Optional Fixing Tie - White

Curved Sections

Comprise Kingspan Thermabate® sections that are factory fabricated to suit any specified radius for bullseye windows, curved heads, etc.



Figure 35: Curved Section

Product details

Standards & approvals

Kingspan Thermabate® is manufactured under a management system certified to ISO 9001: 2015 (Quality Management System), ISO 14001: 2015 (Environmental Management System), ISO 45001: 2018 (Occupational Health and Safety Management System), ISO 50001: 2018 (Energy Management System) and ISO 37301: 2021 (Compliance Management System).

The use of Kingspan Thermabate® sections in profile widths up to and including 150 mm are covered by BBA Certificate 91/2648.



Sustainability & responsibility

Kingspan Insulation has a long-term commitment to sustainability and responsibility: as a manufacturer and supplier of insulation products; as an employer; as a substantial landholder; and as a key member of its neighbouring communities.

A report covering the sustainability and responsibility of Kingspan Insulation Ltd's operations at its Pembridge, Herefordshire and Selby, North Yorkshire manufacturing facilities is available upon request from literature@kingspaninsulation.co.uk

Thermal properties

The thermal conductivity (λ -value) of the rigid thermoset insulation core of Kingspan Thermabate® is 0.034 W/mK.

Durability

If correctly applied, Kingspan Thermabate® has an indefinite life. Its durability depends on the supporting structure and the conditions of its use.

Resistance to solvents, fungi & rodents

Kingspan Thermabate® is resistant to short-term contact with petrol and with most dilute acids, alkalis and mineral oils. However, it is recommended that any spills be cleaned off fully before the products are installed. Ensure that safe methods of cleaning are used, as recommended by suppliers of the spilt liquid.

Kingspan Thermabate® is not resistant to some solvent-based adhesive systems, particularly those containing methyl ethyl ketone, esters and aromatic hydrocarbons (e.g. toluene, xylene, benzene). Adhesives containing such solvents should not be used in association with these products. Damaged product or product that has been in contact with harsh solvents or acids should not be used.

The insulation core and uPVC extrusion used in the manufacture of Kingspan Thermabate® resist attack by mould and microbial growth and do not provide any food value to vermin.

Fire performance

There are restrictions placed upon this product which vary dependant on building type, height, construction and location. For guidance regarding the routes to compliance for meeting the fire safety requirements of the Building Regulations / Standards, refer to the relevant links to Government websites at www.kingspaninsulation.co.uk/fireregulations.

Further details on the fire performance of Kingspan Insulation products may be obtained from the Kingspan Insulation Technical Service Department (see rear cover).

About Kingspan Insulation

Company details

Kingspan Insulation Ltd is part of the Kingspan Group plc., one of Europe's leading construction product manufacturers. The Kingspan Group was formed in the late 1960s and is a publicly quoted group of companies headquartered in Kingscourt, County Cavan, Ireland.

Kingspan Insulation Ltd is a market leading manufacturer of premium and high performance rigid insulation products and insulated systems for building fabric and building services applications.

Products & Solutions

Optimum, premium and high performance rigid insulation products for building fabric applications, including roofs, walls and floors.

- Kingspan AlphaCore® - premium performance microporous silica-based insulation.
- Kingspan OPTIM-R® - optimum performance vacuum insulation panel (VIP) systems.
- Kingspan Kooltherm® - premium performance phenolic insulation.
- Kingspan Therma™ - high performance PIR insulation.
- K-Roc® - rock mineral fibre insulation.
- Kingspan GreenGuard® - extruded polystyrene insulation (XPS).
- Kingspan TEK® - structural insulated panels (SIPs).
- Cavity closers - PVC-U extrusions with an insulation core.
- Membranes - for pitched roofs and walls.

Services

We are proud to offer one of the most advanced support services in the construction industry, designed to give fast and accurate advice no matter what your role is. Visit our website to access the following services.

- U-value calculations - free, quick and easy U-value calculations with our U-value Calculator.
- Help and advice on your projects, including stockists, how to guides, regulatory guidance and e-learning.
- Building Information Modelling (BIM) - download BIM objects for our products.
- Tapered roofing service - Kingspan Insulation's tapered roofing systems come with a supporting design service to ensure the most cost-effective solution for a roof is identified.
- CPDs - Kingspan Insulation offer a number of free CPD seminars for architects and specifiers covering a wide range of industry topics. CPDs can be booked or a range of online learning courses can be found online.

Planet Passionate

Planet Passionate is our 10-year group wide global sustainability strategy aims to impact on three big global issues: climate change, circularity and protection of our natural world.

The Planet Passionate strategy is made up of 12 ambitious targets, addressing the impact of Kingspan's business operations and manufacturing on the four key areas of energy, carbon, circularity and water, with commitments by 2030 to include:

- energy: powering 60% of all Kingspan operations directly from renewable energy with a minimum of 20% of this energy generated on manufacturing sites;
- carbon: achieving net zero carbon manufacturing and a 50% reduction in product CO₂ intensity from primary supply partners;
- circularity: upcycling of 1 billion PET bottles per annum into insulation products plus zero company waste to landfill across all sites; and
- water: harvesting 100 million litres of Kingspan's water usage from rainwater.

Contact details

Kingspan Insulation Ltd

Pembridge | Leominster
Herefordshire | HR6 9LA

T: +44 (0) 1544 388 601

E: info@kingspaninsulation.co.uk

www.kingspaninsulation.co.uk

For individual department contact details please visit

www.kingspaninsulation.co.uk/contact



For the most up-to-date
version of this brochure,
please scan or click [here](#).

To access pre-existing product information or information relating to previously sold/discontinued products please email literature@kingspaninsulation.co.uk.

The information contained in this brochure is believed to be correct at the date of publication. Kingspan Insulation Limited ("Kingspan Insulation") reserves the right to alter or amend the product specifications without notice due to continuous improvement commitments. There may also be relevant changes between publications with regard to legislation, or other developments affecting the accuracy of the information contained in this brochure. Product thicknesses shown in this document should not be taken as being available ex-stock and reference should be made to the current Kingspan Insulation price-list or advice sought from Kingspan Insulation's Customer Service Department. The information, technical details and fixing instructions etc. included in this literature are given in good faith and apply to uses described. Kingspan Insulation does not accept responsibility for issues arising from using products in applications different from those described within this brochure or failure to correctly follow the information or instructions as described within this brochure. Recommendations for use should be verified with a suitable expert or professional for suitability and compliance with actual requirements, specifications and any applicable laws and regulations. For other applications or conditions of use, Kingspan Insulation offers a technical advisory service (see above for contact details), the advice of which should be sought for uses of Kingspan Insulation products that are not specifically described herein. Please check that your copy of this literature is current by contacting the Kingspan Insulation Marketing Department.

© Kingspan, AlphaCore, Kingspan GreenGuard, K-Roc, Kooltherm, OPTIM-R, TEK, Thermabate and the Lion Device are Registered Trademarks of the Kingspan Group plc in the UK, Ireland and other countries. All rights reserved.

TM Therma is a Trademark of the Kingspan Group plc.

Kingspan Insulation Ltd is not associated with, and its products have not necessarily been tested by, the GREENGUARD Environmental Institute.

Registered in England & Wales, No. 01882722. Registered Office: Pembridge, Leominster, Herefordshire HR6 9LA UK. VAT GB428602456.

